

DNA
replication
template

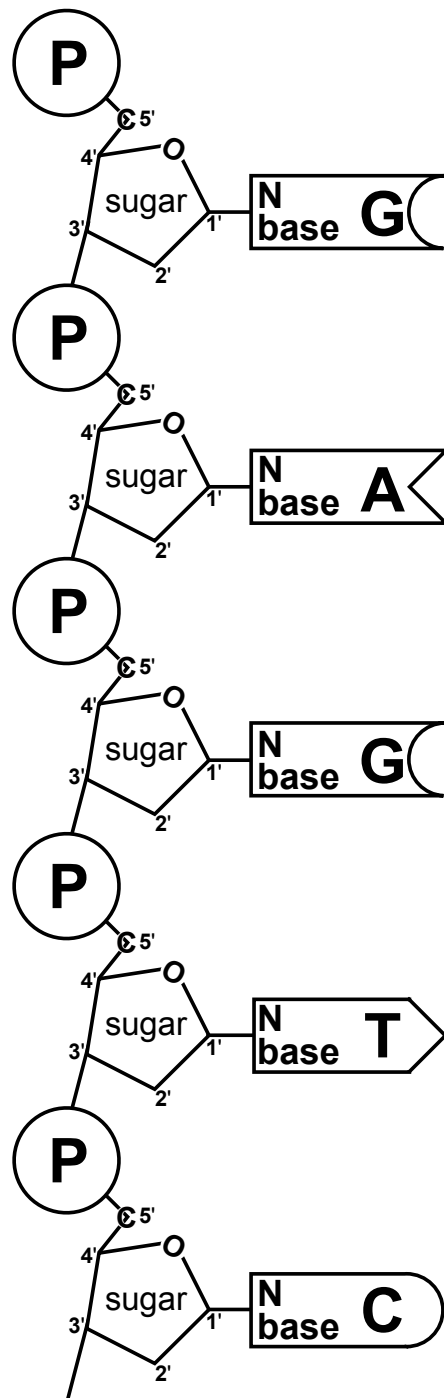

DNA
replication
AMP bases

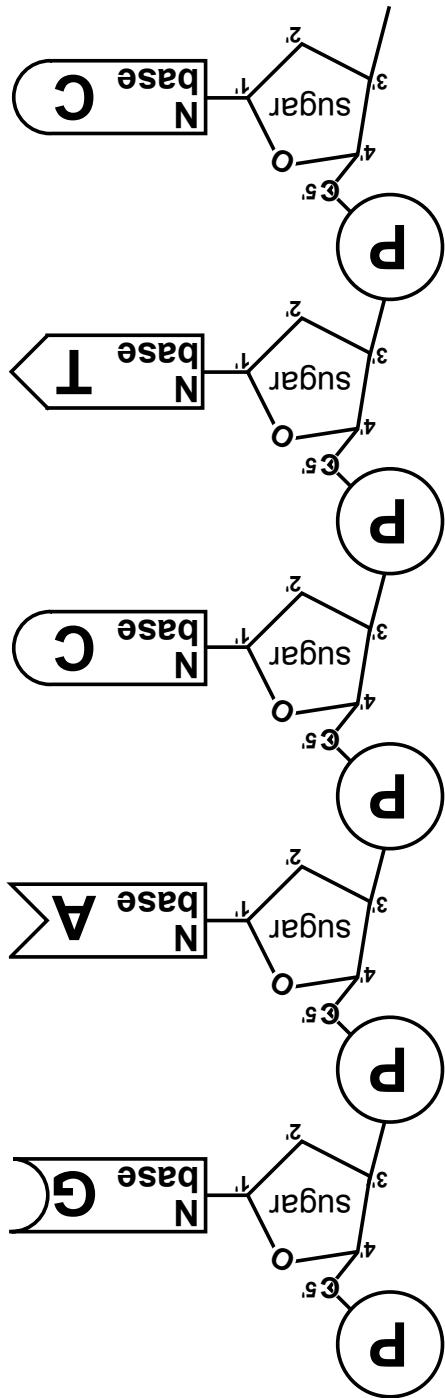
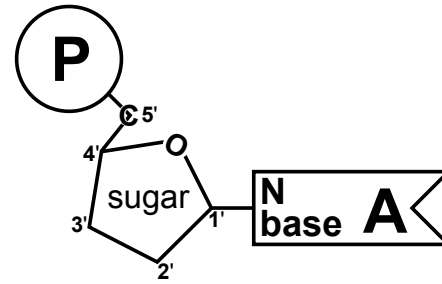
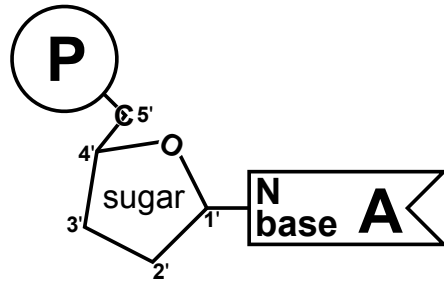
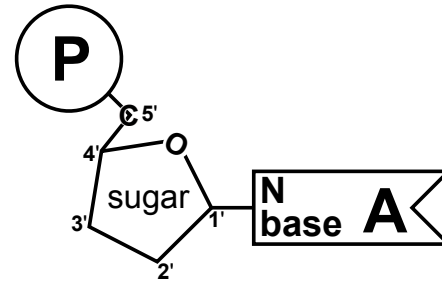
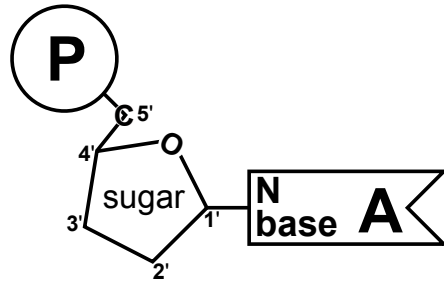
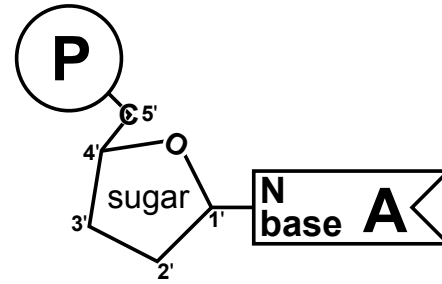
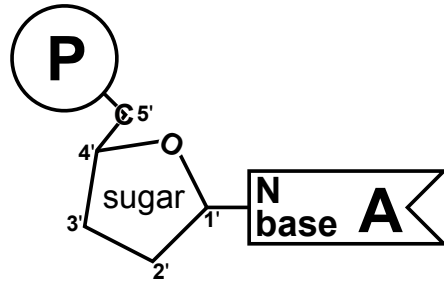
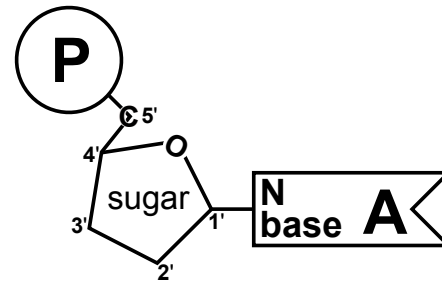
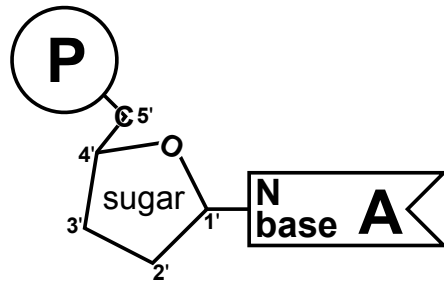

DNA
replication
CMP bases

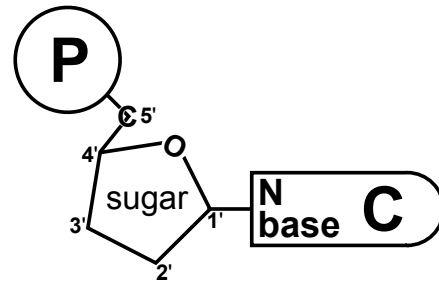
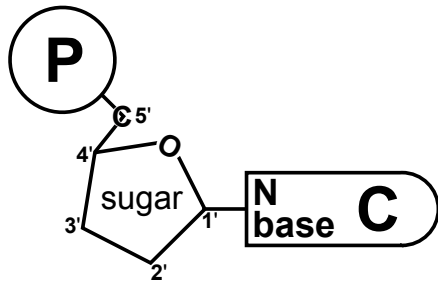
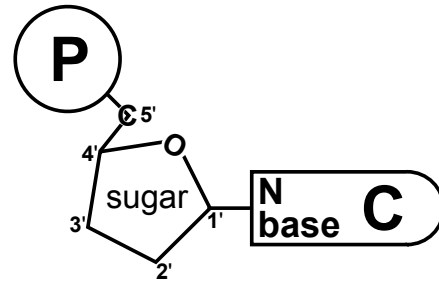
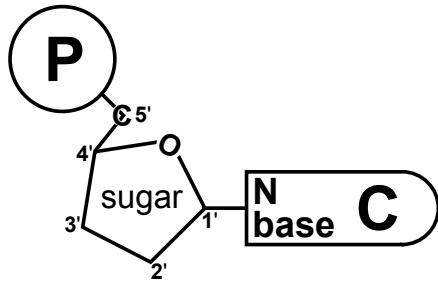
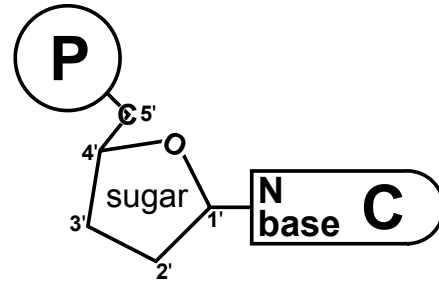
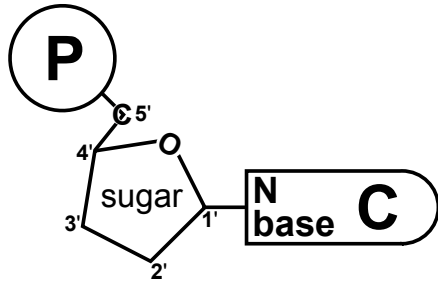
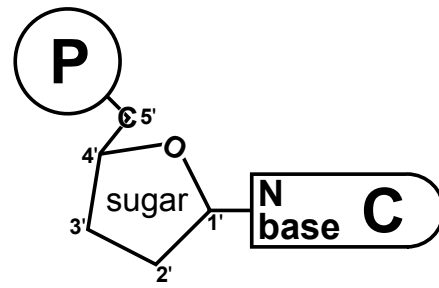
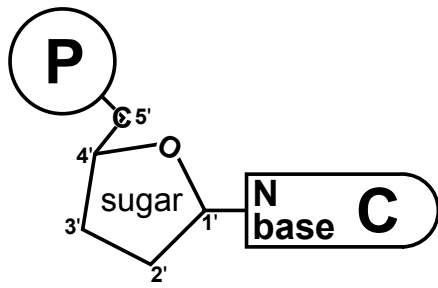

DNA
replication
GMP bases

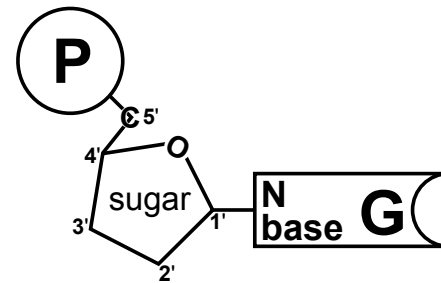
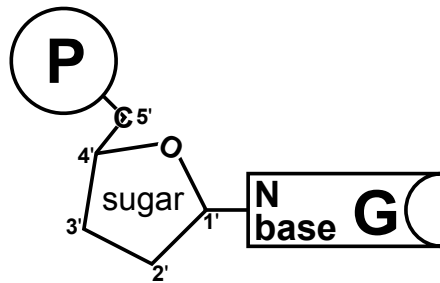
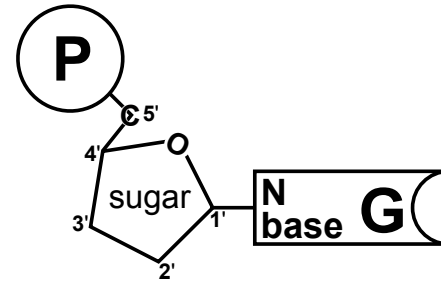
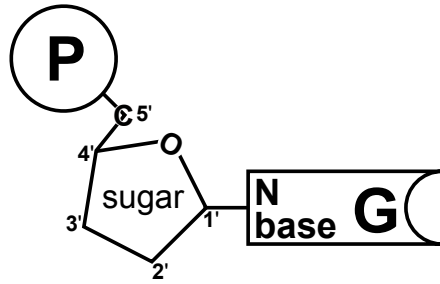
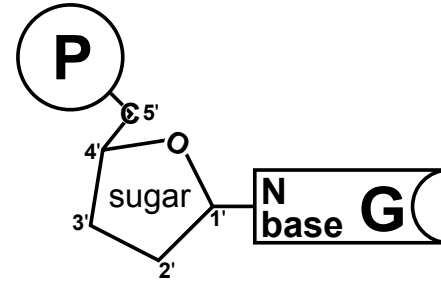
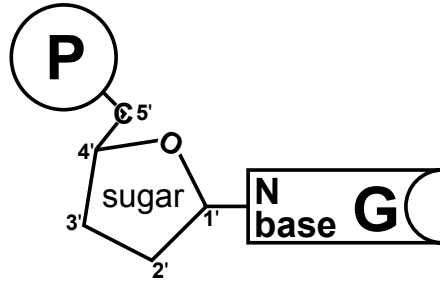
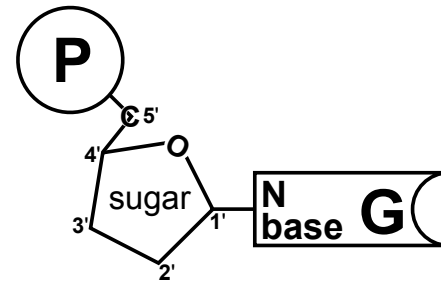
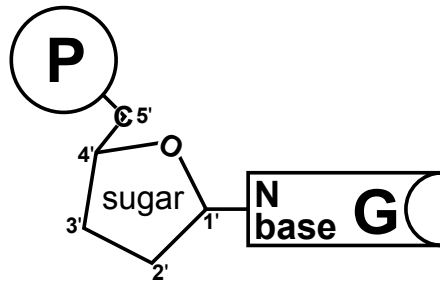

DNA
replication
TMP bases

